

UXL-17

15 kV VOLTAGE TRANSFORMER

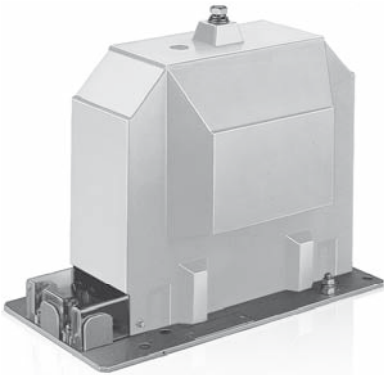

**INDOOR
60 Hertz**

ARTECHE UC/UX/VC series are dry type indoor service voltage transformers. The core is encapsulated with Type B epoxy resin which provides excellent internal dielectric properties and mechanical strength, ensuring a long mechanical and electrical life. The transformer is maintenance free.

The core is built with high permeability grain oriented silicon steel laminations for low losses. The windings are copper wire with copper plate double isolation. The concentric distribution of the coils prevents magnetic flux leakage, achieving greater accuracy and higher capacity to withstand mechanical stresses in adverse operating conditions.

Partial Discharge measurements exceed the IEEE, CAN/CSA and IEC requirements.



Mechanical characteristics		
Insulation Material	Colors	Weight (lbs.)
Resin	Gray*	60

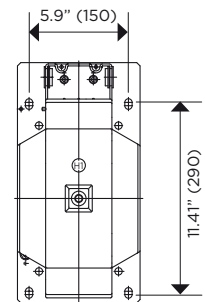
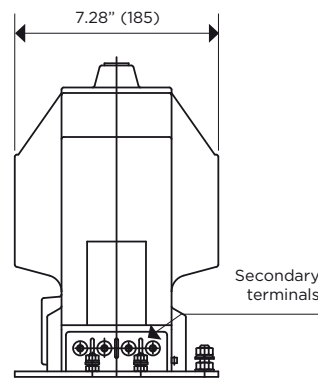
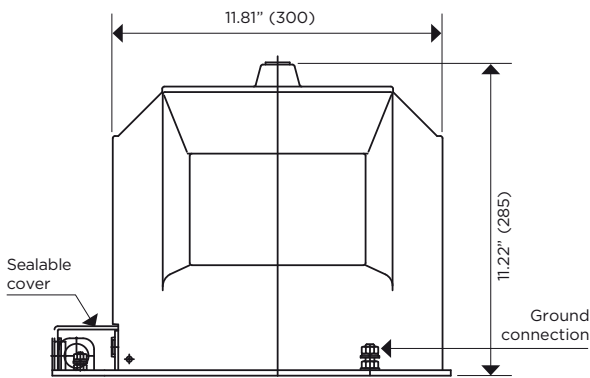

Drawing number: 4286157

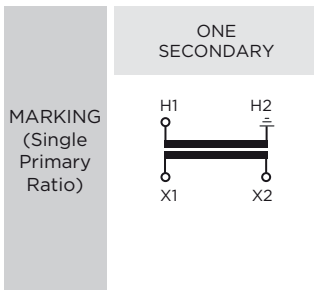

Approximate dimensions in inches (mm).
* Brown color available upon request

